

***TOPAZ[®] Desktop Magnifier
User's Guide***

Freedom Scientific, Inc.

440519-001 Revision D

Freedom Scientific, Inc., 11800 31st Court North, St. Petersburg, Florida 33716-1805, USA
<http://www.FreedomScientific.com>

Copyright © 2012 Freedom Scientific, Inc. All Rights Reserved. TOPAZ[®] is a trademark of Freedom Scientific, Inc. in the United States and other countries. Information in this document is subject to change without notice. No part of this publication may be reproduced or transmitted in any form or by any means electronic or mechanical, for any purpose, without the express written permission of Freedom Scientific.

Technical Support

To contact **Technical Support** by telephone, U.S. customers can call **(727) 803-8000**, Monday through Friday, 8:30 AM to 7:00 PM (Eastern Time).

To contact by e-mail, send questions to **Support@FreedomScientific.com**.

To search the knowledge base, visit **www.FreedomScientific.com** and choose the Support link.

Table of Contents

Transporting and Moving TOPAZ	1
Steps to Use TOPAZ	4
Advanced Operation	10
Focus Lock.....	10
Turning LED Reading Lights On or Off	11
Using the Reading Line.....	12
Appendix A – Changing TOPAZ Settings.....	14
TOPAZ Settings	14
Opening Configuration Mode and Editing TOPAZ Settings	14
Customizing Magnification Settings	17
Selecting a Magnification Table	18
Changing the Magnification Display Number	19
Reset Factory Default Settings	21
Display Firmware Version Number	22
Appendix B – Rear Panel Connectors.....	23

Transporting and Moving TOPAZ

Use this image and the text on pages 2 through 3 to lift, carry, and position the TOPAZ.

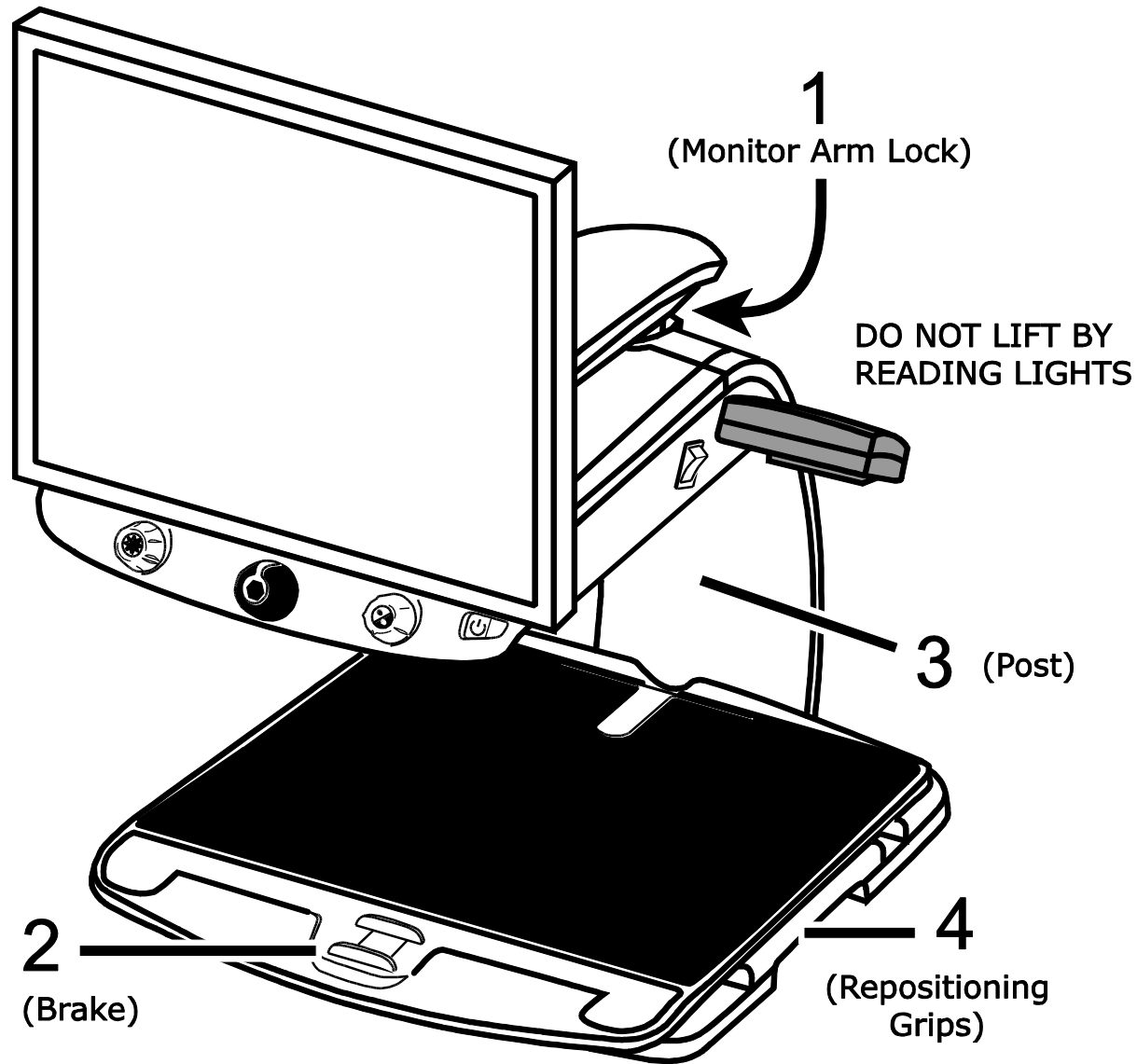

1. Lock the monitor arm to secure and prevent the monitor from moving to the left or right.

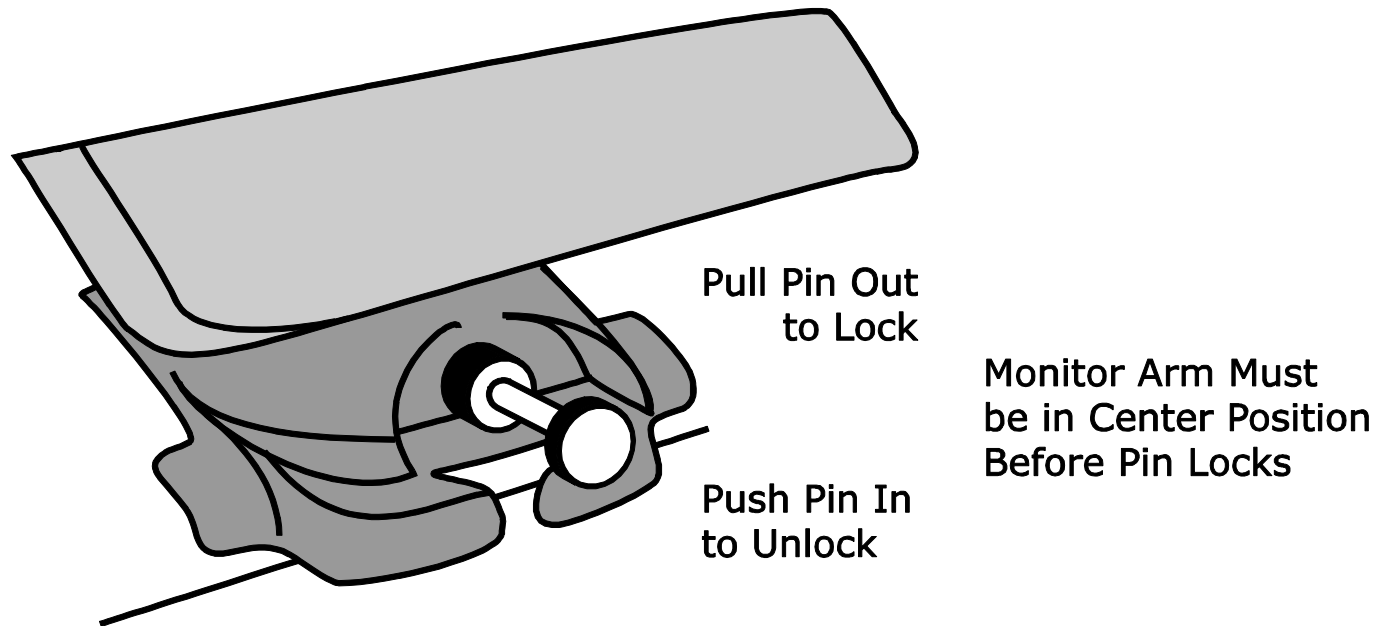

2. Lock the **XY reading table** to stop it from moving by pushing the red brake lock toward the TOPAZ.
3. Lift and transport the TOPAZ by the **rear post** to move it to a sturdy surface such as a table, desk, or countertop. One suggested method is to wrap your forearm around the rear post and then lift.

Important: Do NOT lift TOPAZ by the LED reading lights.

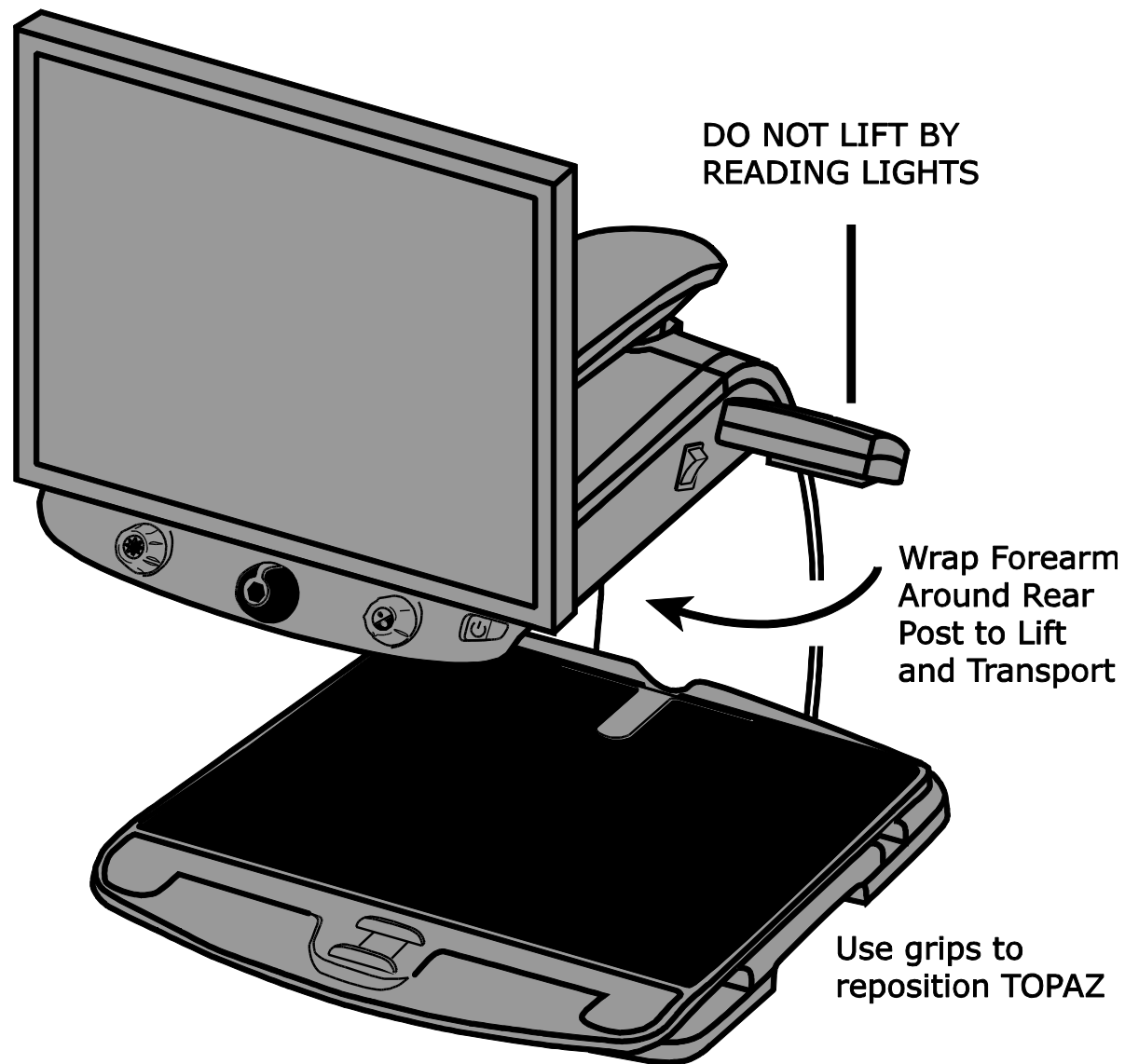

4. Use the **repositioning grips** on both sides of the reading table to move and position TOPAZ to your liking once it is on a sturdy surface.

Steps to Use TOPAZ

Use this image and the steps on pages 5 through 9 to turn on and begin using the TOPAZ.

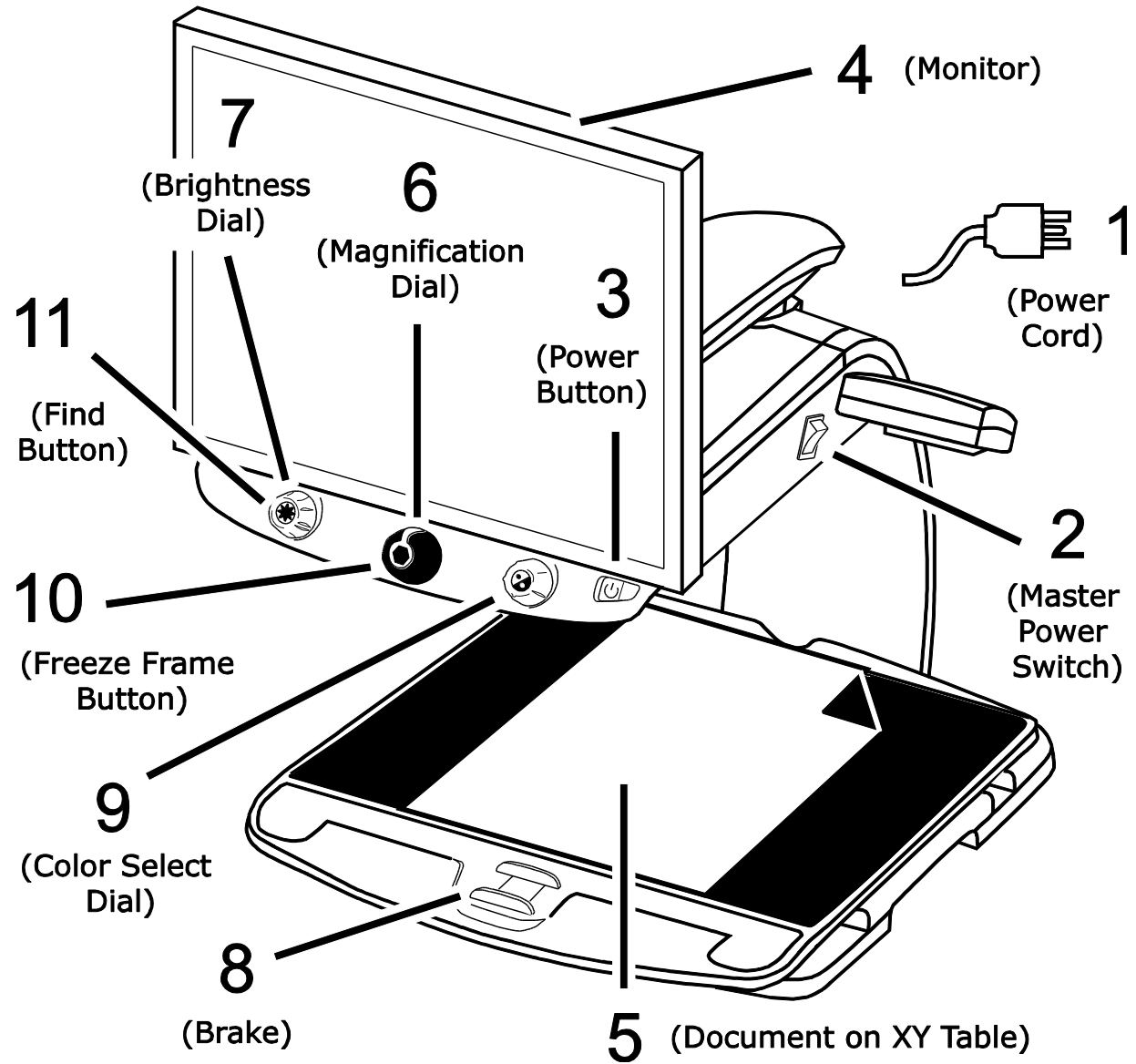

1. Plug the **power cord** from the middle power connector on the rear of the TOPAZ to an electrical wall outlet.
2. Press the **white master power switch** located near the LED reading light on the right side of the TOPAZ.
3. Press the **green standby power switch** on the right side of the control panel.

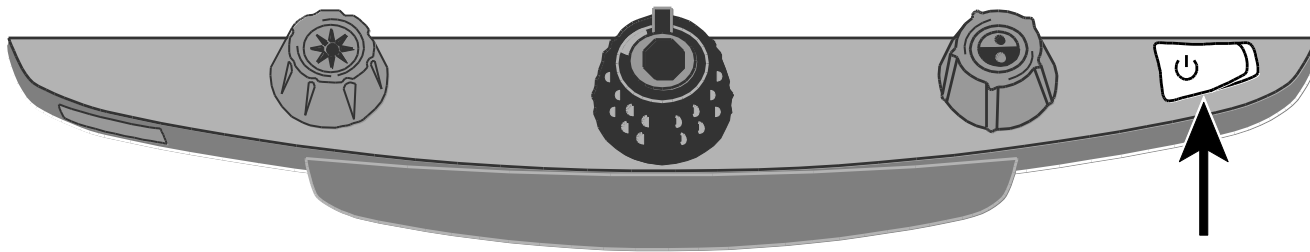

Note: If the monitor screen remains blank, make sure that the monitor is turned on.

4. Hold the sides of the monitor with both hands and move it up or down to change the height, or turn the monitor left or right to adjust the angle for the best view.

If the monitor does not move to the left or right, make sure to release the arm lock (push the locking pin in) located at the base of the monitor arm. Also, make sure that the monitor is raised up so that it freely moves from left to right.

For arm lock information, refer to *Transporting and Moving TOPAZ* as previously mentioned in this document.

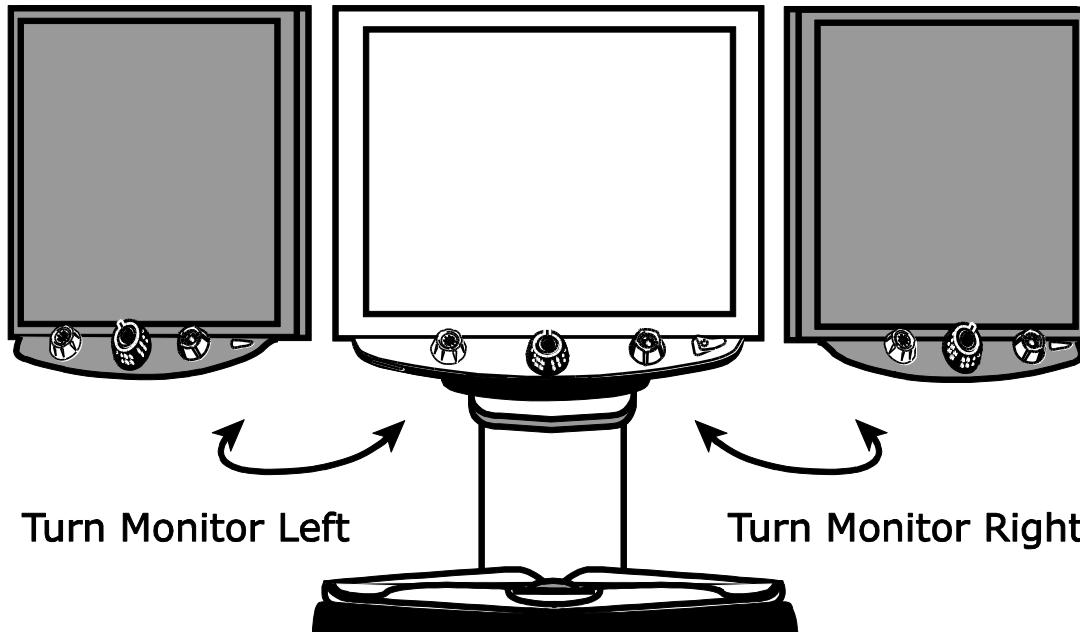
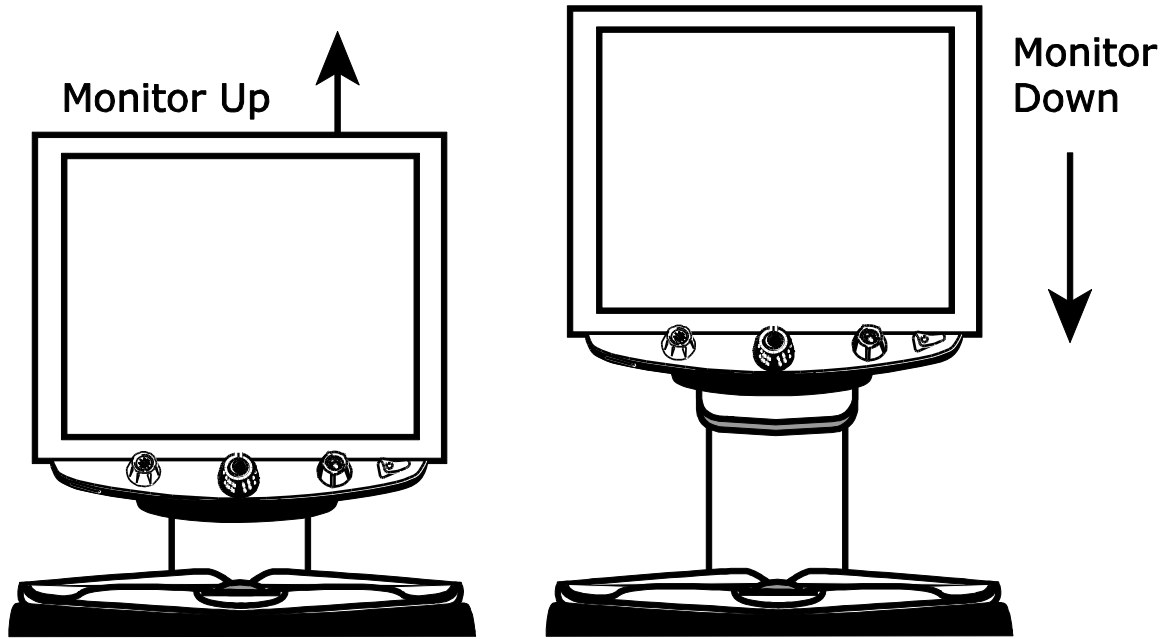

Raise Monitor Up
and Unlock
Monitor Arm
Before Turning
Left or Right

5. Place the document that you want to magnify onto the center of the reading table. Move the document back so that it touches the rear of the XY table. To read a pill bottle, place it in the indentation located at the rear of the XY table. This prevents the bottle from rolling on the table.
6. Turn the **black Magnification dial** to adjust magnification.

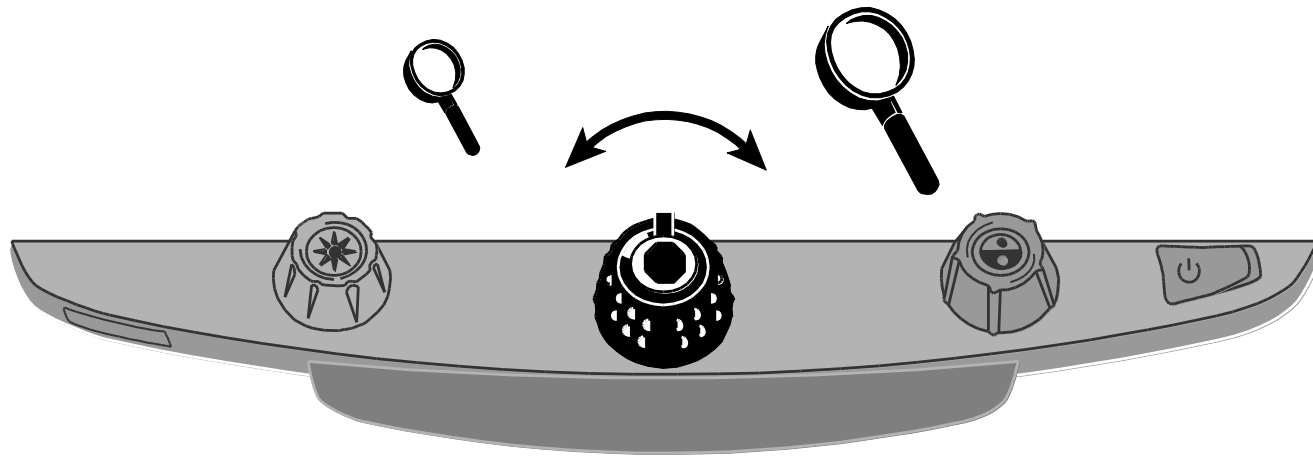

7. Turn the **yellow Brightness dial** to adjust brightness.

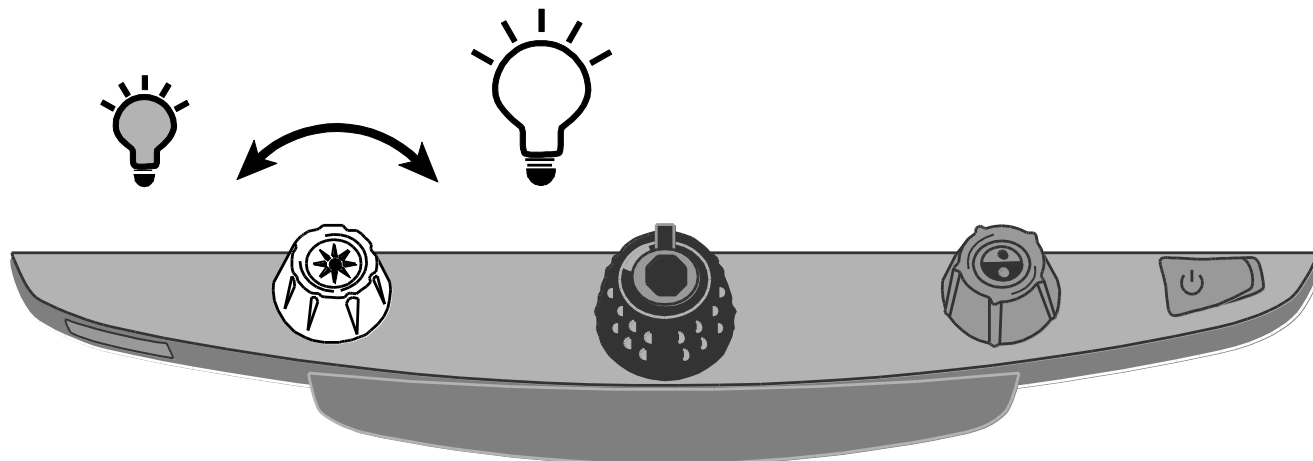

8. Unlock the **reading table** to move a document so that its text moves back and forth across the screen to make reading easier.

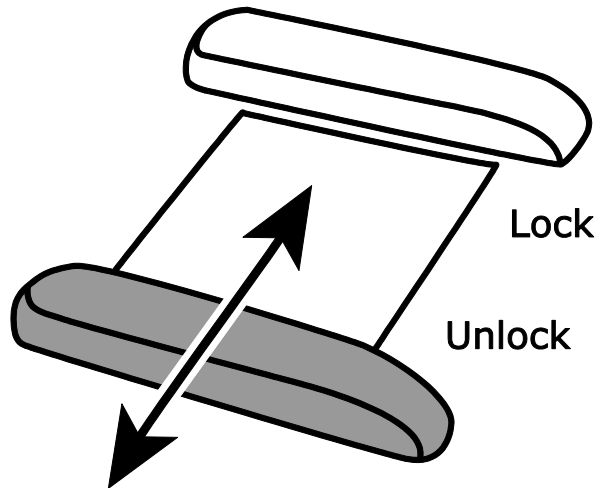

9. Turn the **blue Color Select dial** to choose a color mode that best suits your vision needs. Default color modes are full color; black on white; white on black; yellow on blue; and yellow on black.

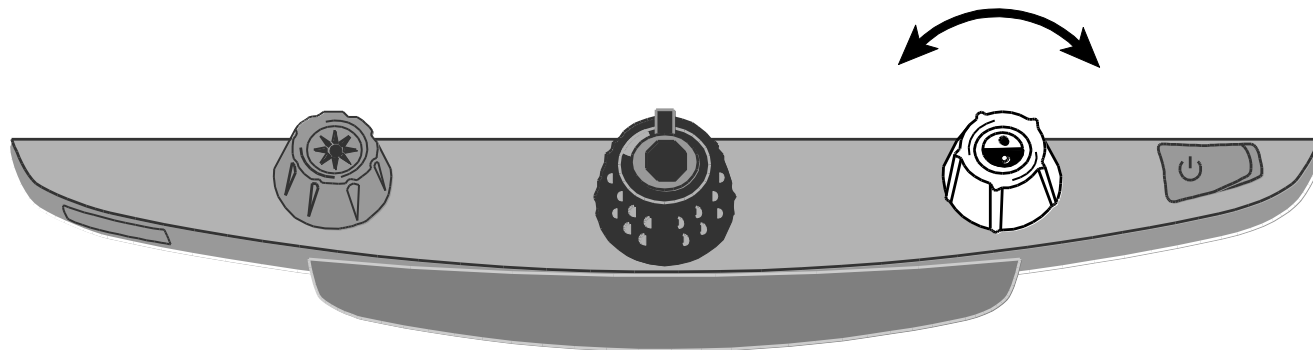

10. Press the **Freeze Frame button** located in the center of the **black Magnification dial** to freeze the current image on the screen. Press it again to return to the live view.

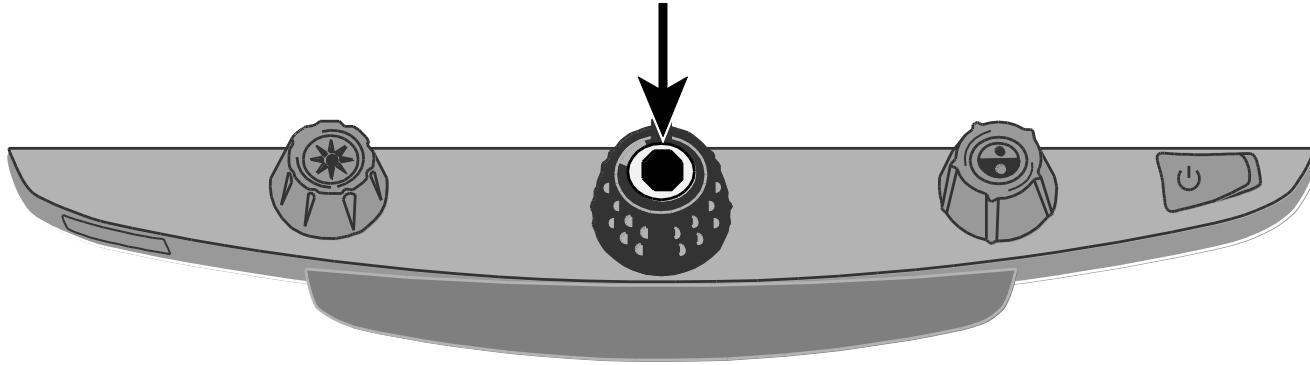

11. Press and hold the **Find button** located in the center of the **yellow Brightness dial** to zoom out and see more of the document. A set of crosshairs display on the monitor screen. Move the XY table and use the crosshairs to center and view a new area of the document.

Release the **Find button** to turn off the crosshairs and zoom back in on the new area of the document.

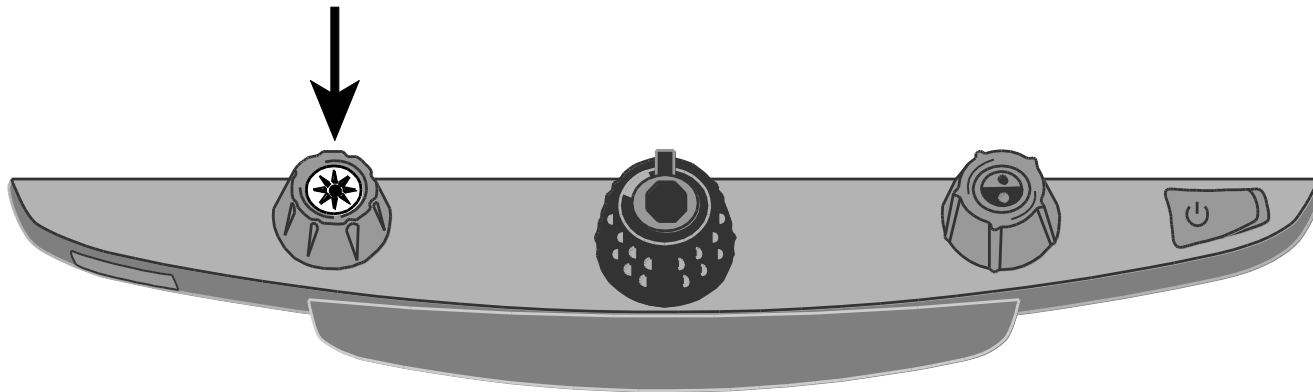

Focus Lock

By default, the camera automatically focuses on the closest object in view. However, if you want focus to remain on a specific object such as a document on the XY table, you can turn on the Focus Lock feature. This prevents the camera from accidentally focusing on your hand or any other item that moves in front of the camera. During normal operation, it is recommended that you leave Focus Lock off.

To use Focus Lock, do the following:

1. Press the **red Focus Lock button** once to turn on Focus Lock. The padlock icon appears on the screen: .
2. Press it a second time to turn off Focus Lock and restore automatic focus.

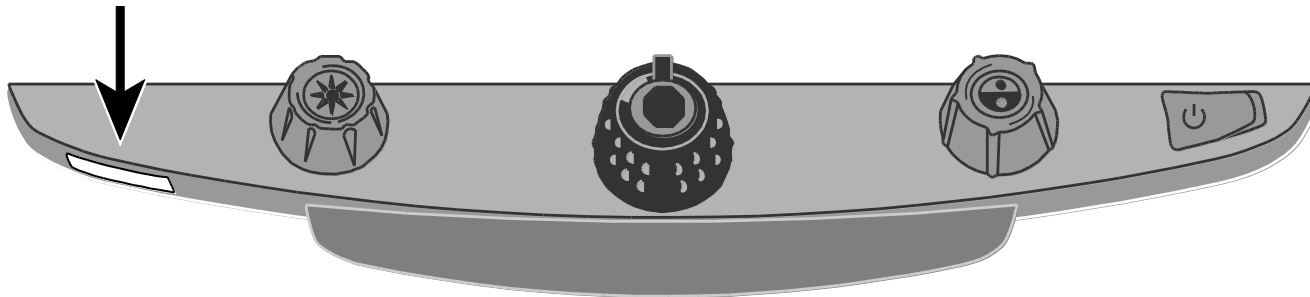

Turning LED Reading Lights On or Off

Note: TOPAZ has two lights designed to illuminate documents and other items that you place on the reading table. This lighting is diffused to reduce glare and reflections. However, some items, such as photographs or glossy magazine pages, may be too shiny or reflective to view easily. When viewing such items, you can turn off the reading lights if you like.

1. To turn off the LED reading lights, press and hold the center of the **yellow Brightness dial** and the **red Focus Lock button** simultaneously.
2. Press and hold both again when you want to turn the reading lights on.

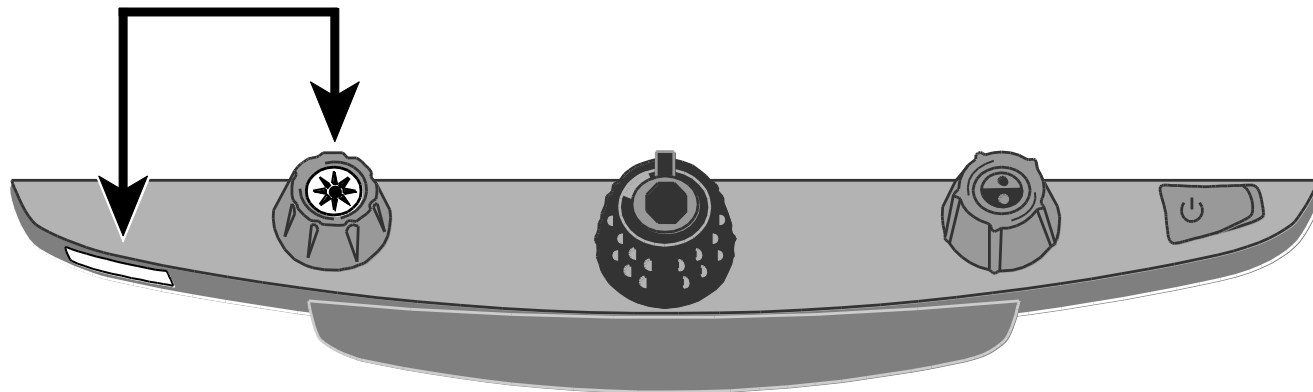

Using the Reading Line

The reading line is a horizontal line that displays on the screen to help you maintain your place while reading a document. It is useful when using the XY table to scroll your document across the screen.

To use the reading line, do the following:

1. Press the center of the **blue Color Select dial** to place a horizontal line across the screen.

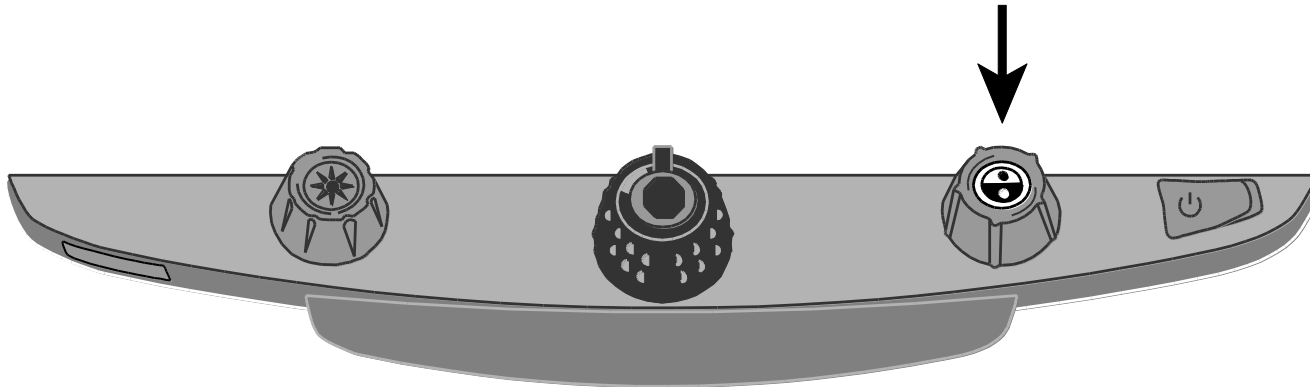

The line displays approximately one third of the way up from the bottom of the screen.

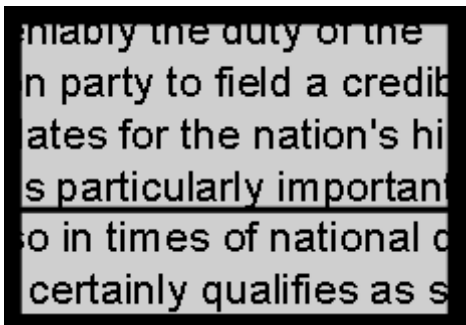

2. Next, move the XY table to the right to continue reading text. To read the next line, move the reading table away from you so that the reading line displays under the next line of text. You can then slide the XY table to the left side of the document to continue reading.
3. To remove the reading line from the screen, press the center of the **blue Color Select dial** again.

Appendix A – Changing TOPAZ Settings

TOPAZ Settings

- TOPAZ can be configured for up to 12 color mode settings known as positions 1 through 12. Color modes are used to show text for best readability, for example, yellow text against a blue background.
- Positions 1 through 3 are Full Color (true color), Black on White, and White on Black. The color settings for these positions cannot be changed.
- Positions 4 through 12 can be customized or turned off. By default, positions 4 and 5 are Yellow on Blue and Yellow on Black, but they can be changed.

Opening Configuration Mode and Editing TOPAZ Settings

1. When configuring color modes, it is best to have both a page of text and a color photo to place under the TOPAZ camera.
2. Press and hold the **red Focus Lock button** for approximately 10 seconds to enter the Configuration menu. (Press and hold the button again at any time to exit the Configuration menu and save your settings.)

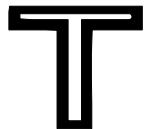

Hollow outline:
Color mode edits not allowed



Solid outline:
Edits to all settings are allowed

The letter **T**, which stands for text enhancement, displays in the lower left corner of the screen. Position 1 always displays first. A hollow **T** displays for positions 1 through 3. This means that color settings cannot be changed; however, other settings can be edited for these positions. A solid **T** displays for positions that can be edited. The position number also displays on the screen as the rightmost icon.

3. Turn the **blue Color Select dial** to select the customizable positions 4 through 12.
4. Turn the **yellow Brightness dial** to view the 33 available color settings. There are 30 two-color text enhancement modes, as well as True Color (which is position 1), grayscale, and high color. Once you get to the mode that you want to set for that position, press the center of the **black Magnification dial** to select (✓) that position. An X icon (✗) means that the position is disabled.
5. Press the **red Focus Lock button** to step to Freeze Frame: **II**. You can turn off the Freeze Frame feature by pressing the center of the **black Magnification dial**, which changes the check box icon to an X icon.
6. Press the **red Focus Lock button** to step to Focus Lock: **🔒**. You can turn off the Focus Lock feature by pressing the center of the black Magnification dial, which changes the check box icon to an X icon.
7. Press the **red Focus Lock button** again to step to Magnification Levels: **AAA**. The default setting is 1. Setting 2 gives you finer adjustment at the lower magnification range (positions 1 through 5); setting 3 gives you finer adjustment in the middle magnification range (positions 6 through 10). Press the center of the **black Magnification dial** to select setting 1, 2, or 3.



8. Press the **red Focus Lock button** again to step to Magnification Display Number: **88**. Press the center of the **black Magnification dial** to select how the magnification level is displayed on the screen:



Position number (1 through 16)



No display



X value (Magnification power – 3.5x, 6x, 10x, and so on)

9. Press and hold the **red Focus Lock button** for 10 seconds to exit the configuration settings and save changes.

Customizing Magnification Settings

The TOPAZ can display 16 levels of magnification. To increase magnification, turn the **black Magnification dial** clockwise. To decrease magnification, turn it counterclockwise.

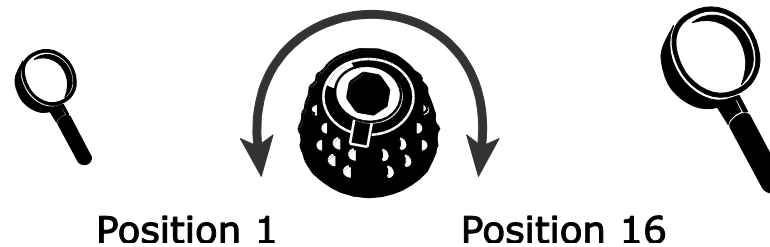

To get the most out of TOPAZ, there are three magnification tables from which you can choose the best magnification power for you.

- **Table 1** is the default magnification table and is ideal for most users. Turn the **black Magnification dial** to step through positions 1 through 16.
- **Table 2** is ideal if you are comfortable with lower magnification. It provides finer adjustments between positions 1 through 5.
- **Table 3** provides finer adjustments for midrange magnification available between positions 6 through 10. This table is good if you need greater magnification.

Experiment with the different magnification tables and use the one that is best for you. You can always revert to table 1 at any time if you are not comfortable with the magnification available in tables 2 and 3. The following describes how to select and edit your viewing preferences.

Selecting a Magnification Table

1. Press and hold the **red Focus Lock button** for approximately 10 seconds until the letter **T** displays in the lower left corner of the screen.
2. Continue to press the **red Focus Lock button** until the video magnification icon displays on the screen.

AAA

3. Press the center of the **black Magnification dial** to select one of the three magnification tables. For an overview of magnification tables, refer to the descriptions provided earlier in this appendix.
4. Do one of the following:
 - To save the change and exit configuration mode, press and hold the red Focus Lock button for approximately 10 seconds until the on-screen display at the bottom of the screen closes.
 - To customize how magnification values display on the screen, perform the steps in the next section.

Changing the Magnification Display Number

Note: The following assumes that you are continuing from the magnification table procedure. If not, press and hold the **red Focus Lock button** for approximately 10 seconds to open the TOPAZ settings. Next, continue to press the **red Focus Lock button** until the magnifying glass icon displays on the screen.

Once you have selected a magnification table, you can choose whether or not the current magnification value displays on the screen as you turn the black Magnification dial. To set your preference, do the following:

1. Press the **red Focus Lock button** until the magnifying glass icon displays on the screen.
2. Press the center of the **black Magnification dial** to select how magnification values display. This is represented by the magnifying glass icon.



Displays Magnification
Positions 1 through 16



Displays Actual
Magnification Values
(2.2, 3.9, 7.5 and so on)



Displays No
Magnification Value

Select one of three options:

- Select the icon with the number 88 to display the magnification in use relative to the 16 positions of the **black Magnification dial**.
 - Select the icon with an X to display the actual magnification value, for example, 2.2, 3.9, 7.5, and so on.
 - Select the icon with the clear magnifying glass if you do not want to see a magnification value display as you turn the **black Magnification dial**.
3. To save changes and exit configuration mode, press and hold the **red Focus Lock button** for approximately 10 seconds until the on-screen display at the bottom of the screen closes.

To discard any changes made while configuration mode is open, do not touch any control panel dials, buttons, switches, or wheels for approximately 30 seconds. This closes configuration mode without saving changes.

Reset Factory Default Settings

Press and hold the following dials and buttons simultaneously for 10 seconds to reset TOPAZ to its default factory settings. Release the dials and buttons when the screen goes blank.

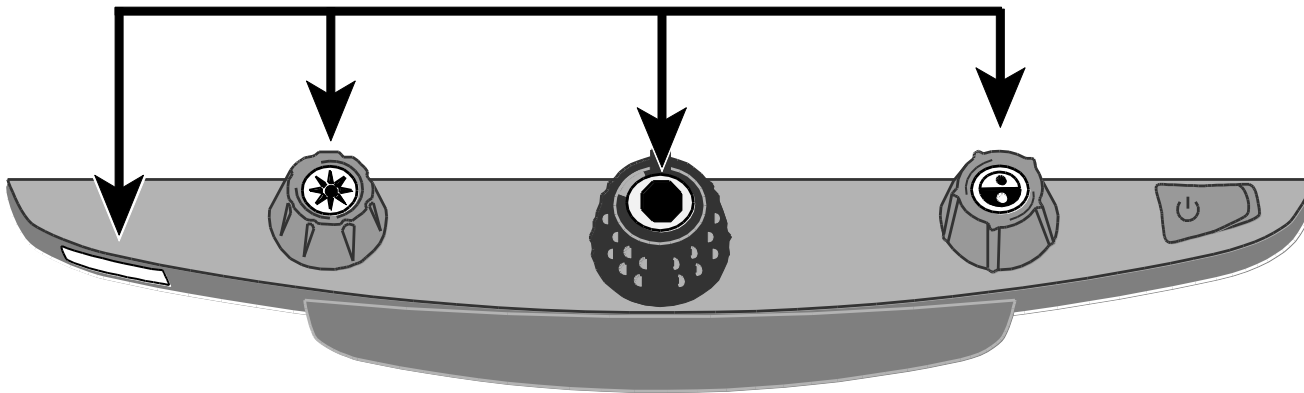

- Red **Focus Lock** button
- Center of yellow **Brightness** dial
- Center of black **Magnification** dial
- Center of blue **Color Select** dial

Display Firmware Version Number

Press and hold the following dials and buttons simultaneously for five seconds to display the firmware version number. The word **Ver.** followed by three sets of numbers, which represent the major and minor firmware numbers, flash one at a time on the screen.

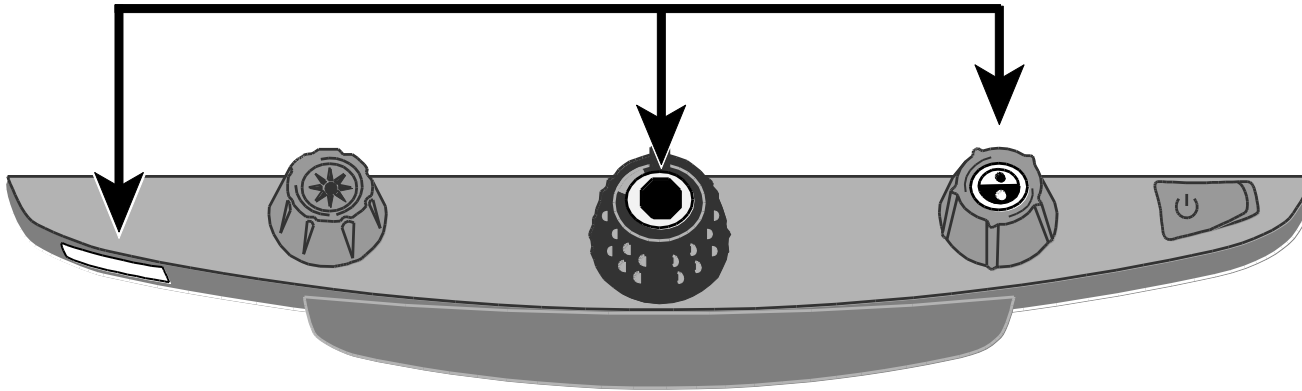

- Red **Focus Lock** button
- Center of black **Magnification** dial
- Center of blue **Color Select** dial

Appendix B – Rear Panel Connectors

Use this image and the descriptions on the next page to identify TOPAZ connectors.

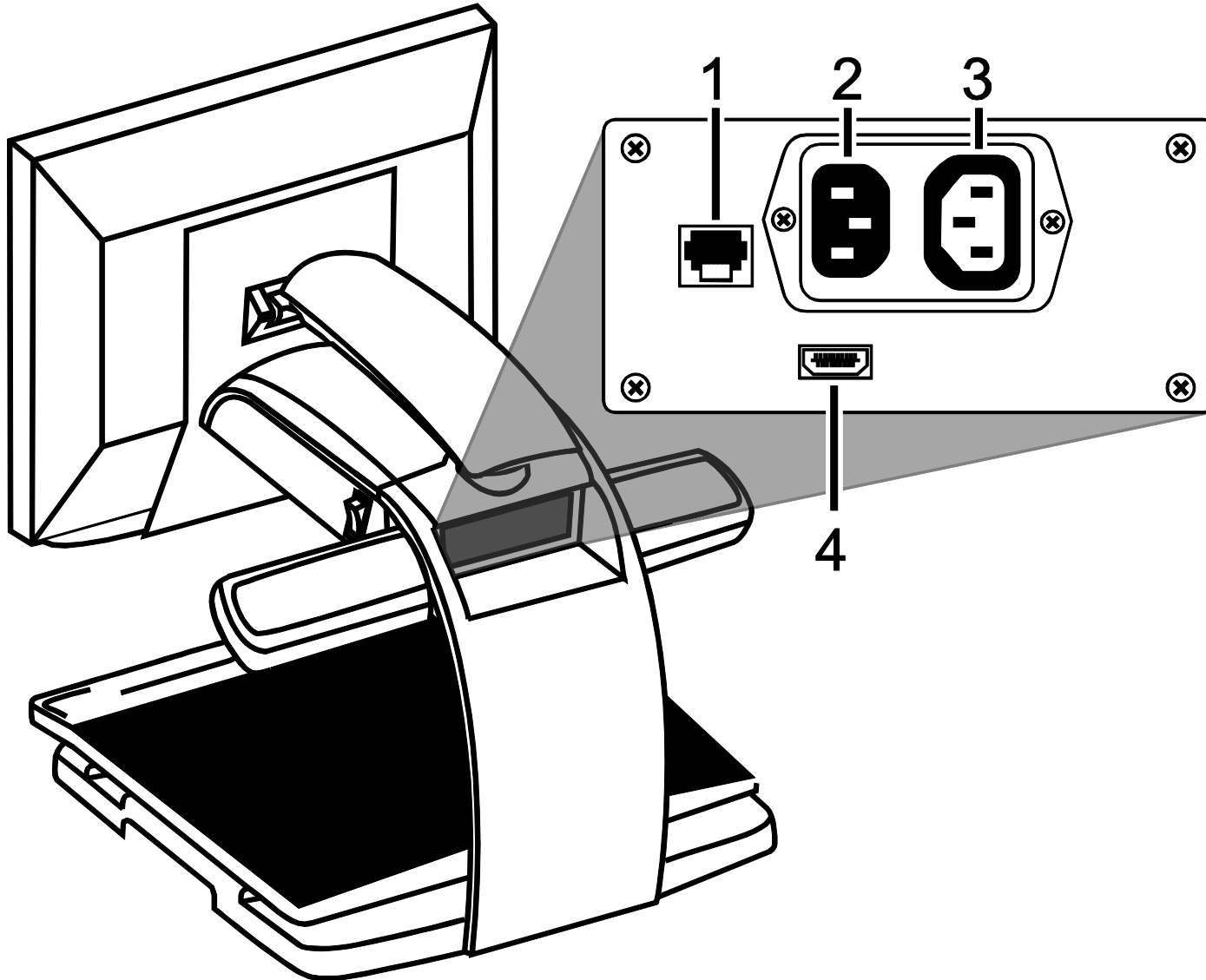

1. **Control panel jack:** Modular jack that connects the control panel to the TOPAZ camera. Do not disconnect cable unless servicing the unit.
2. **AC power connector:** Plug power cord from wall outlet to TOPAZ.
3. **Monitor power connector:** Plug power cord from monitor to TOPAZ.
4. **Monitor DVI connector:** Connects the TOPAZ monitor to the TOPAZ camera. There is no need to remove this monitor cable under normal operation.

Federal Communications Commission Notice

This equipment has been tested and found to comply with the limits for a Class B digital device, pursuant to Part 15 of the FCC Rules. These limits are designed to provide reasonable protection against harmful interference in a residential installation. This equipment generates, uses, and can radiate radio frequency energy and, if not installed and used in accordance with the instructions, may cause harmful interference to radio communications. However, there is no guarantee that interference will not occur in a particular installation. If this equipment does cause harmful interference to radio or television reception, which can be determined by turning the equipment off and on, the user is encouraged to try to correct the interference by one or more of the following measures:

- Increase the separation between the equipment and receiver.
- Connect the equipment into an outlet on a circuit different from that to which the receiver is connected.
- Reorient or relocate the receiving antenna.
- Consult the dealer or an experienced radio or television technician for help.
- Changes or modifications not expressly approved by Freedom Scientific could void the user's authority to operate the equipment.

Industry Canada ICES-003 Notice

This Class B digital apparatus complies with Canadian ICES-003.
Cet appareil numérique de la classe B est conforme à la norme NMB-003 du Canada.

Regulatory Compliance

CAUTION

Possibly hazardous optical radiation emitted from this product.

PRUDENCE

Le rayonnement optique probablement hasardeux a émis de ce produit.

- **Wavelengths:** 400 nm to 780 nm
- **Power:** 100-240V~ 1A 47-63Hz
- **Safety:** IEC 60950-1 IEC 60950-1 / UL 60950-1 / CSA C22.2.60950-1 / EN 60950-1: 2006 + A11:2009 + A1:2010
- **EMC:** FCC (CFR-47, part 15) Class B; Industry Canada ICES-003; EN 55022 Class B; EN 55024

Safety and Maintenance

Do not stare at the lamp as it may be harmful to the eyes.

Important Safety Instructions

Read and follow all warning notices and instructions marked on the product or included in the manual.

- Slots and openings in the product are provided for ventilation. To ensure reliable operation of the product and to protect it from overheating, these slots and openings must not be blocked or covered.
- Do not allow anything to rest on the power cord, and do not locate the product where persons will walk on the power cord.
- Do not attempt to service this product yourself, as opening or removing covers may expose you to hazardous voltage or to other risks. Refer all servicing to qualified service personnel.
- When installed, the product must comply with the applicable Safety Standards and regulatory requirements of the country in which it is installed. If necessary, consult with the appropriate regulatory agencies and inspection authorities to ensure compliance.
- Always operate the product in a place where the temperature is between 10° and 35s° C (50° and 95° F).
- Keep it away from wet areas, rain, and other sources of liquids. Do not submerge the product.
- Do not stare directly at the light emitted by the reading lamp as the bright light may be harmful to the eyes.
- Do not attempt to move the product without first locking the monitor arm and reading table.